

## M3 ELECTRICAL AIR CONDITIONING

Gruppo Condizionatore a tetto Elettrico 80 Volt

80 Volt Electric Rooftop Air Conditioning Unit

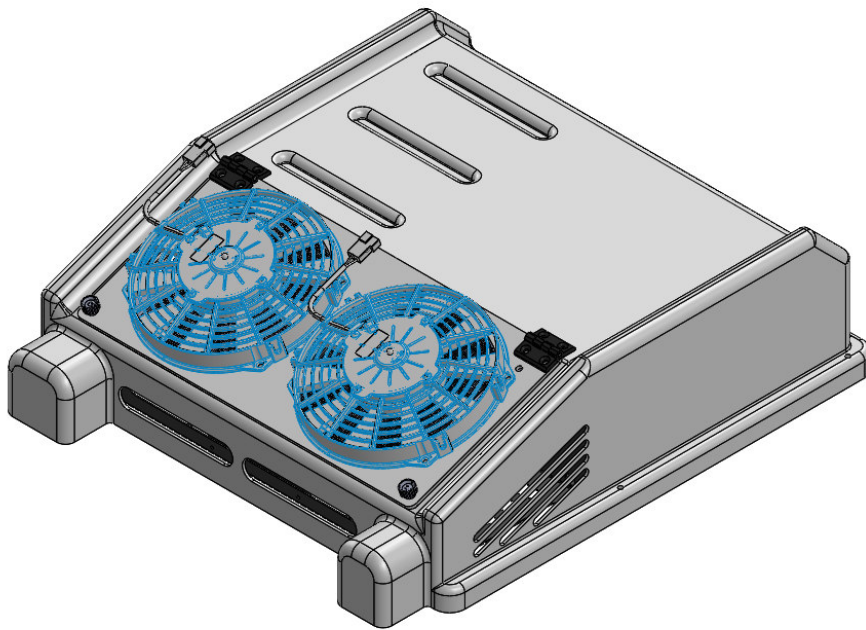

### Posizione in cabina – Position in the Cabin

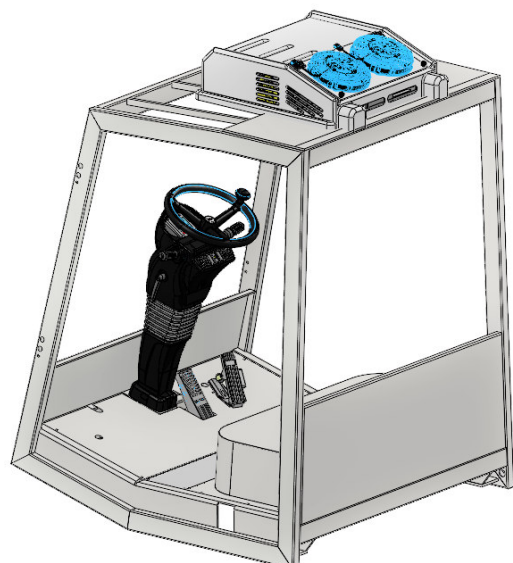
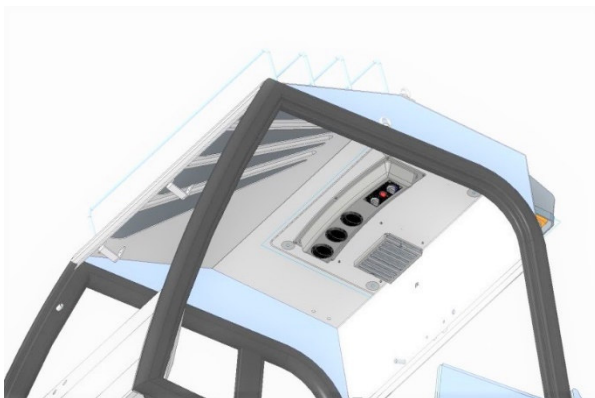

# VAC AC Electrical Units

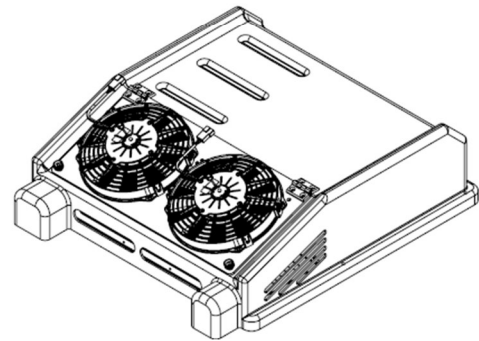
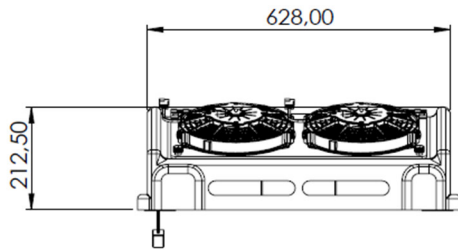
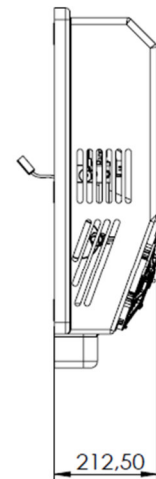
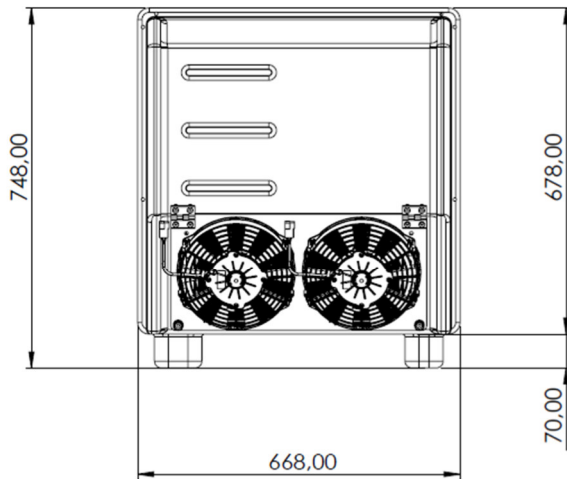

## ELECTRICAL VAC AIR CONDITIONING

Gruppo condizionatore a tetto elettrico - Electric roof-mounted air conditioning unit

Codice Componente – Component Code	U72FF.1 Version 80V@24V
	U92FF Version 80V@12V
Classe di protezione – Protection Class	IP44
Potenza in raffreddamento @+40° Cooling Power @+40°	3.5 Kw
Portata Aria (bocca libera) AirFlow (free mouth)	530 m3/h
Assorbimento Elettrico Power consumption	Servizi @12V= 28Ah - @24V=18Ah – Services @12V= 28Ah - @ 24V = 18Ah Condizionamento 80V=15Ah – Air conditioning 80V = 15Ah
Velocità ventilatore Ventilation Speed	3
Refrigerante - Refrigerant	R134a (incluso – included)
Peso - weight	31 Kg
Note Notes	