

M3 ELECTRICAL AIR CONDITIONING

Gruppo Condizionatore a tetto Elettrico 24 Volt

24 Volt Electric Rooftop Air Conditioning Unit

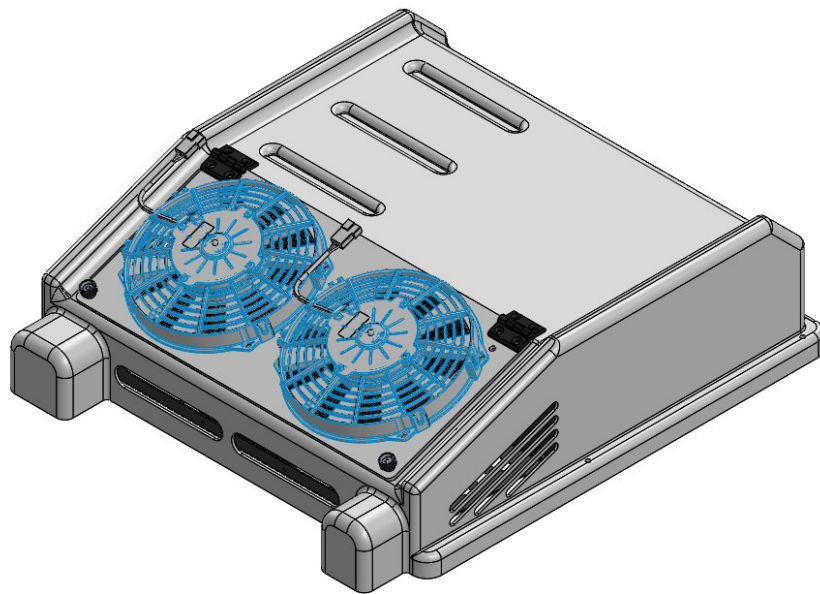

Posizione in cabina – Position in the Cabin

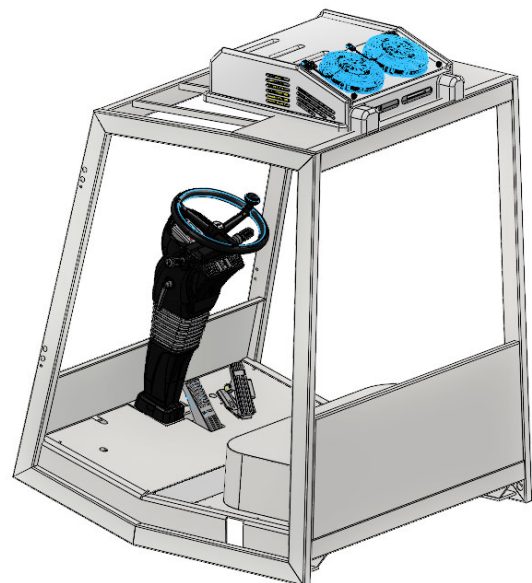
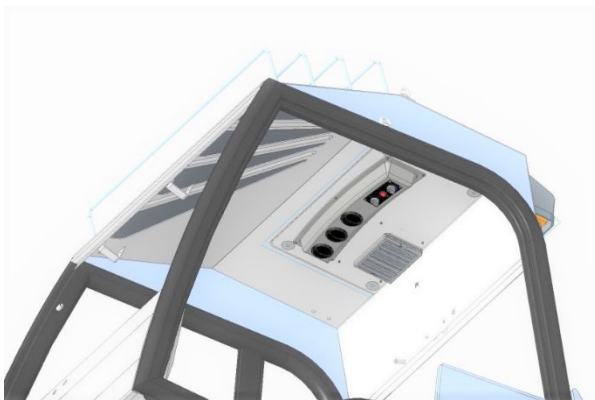

VAC AC Electrical Units

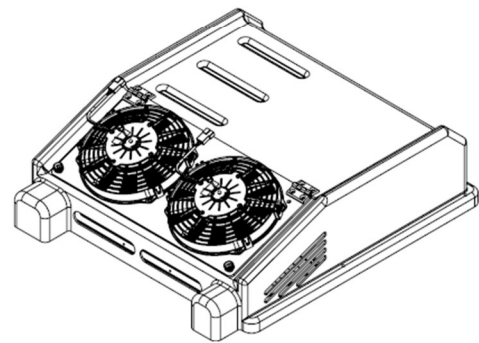
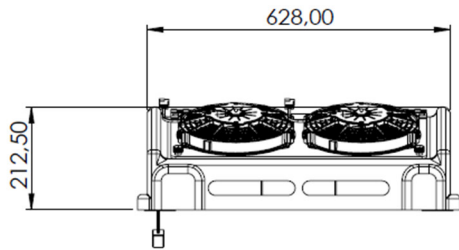
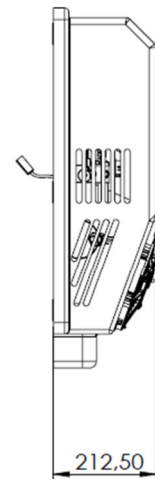
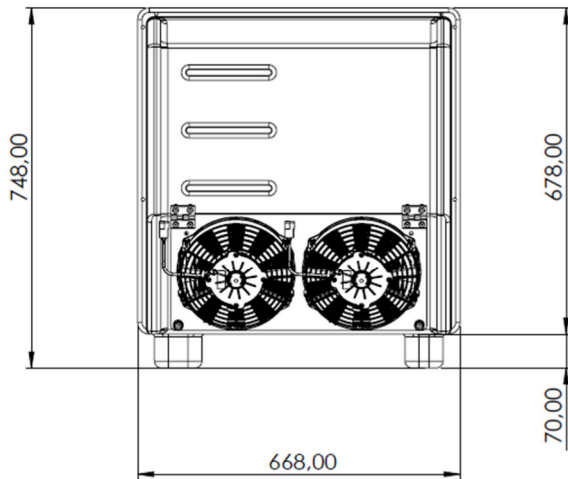

ELECTRICAL VAC AIR CONDITIONING

Gruppo condizionatore a tetto elettrico - Electric roof-mounted air conditioning unit

Codice Componente – Component Code	U106FF Version @24V
Classe di protezione – Protection Class	IP44
Potenza in raffreddamento @+40° Cooling Power @+40°	3 Kw
Portata Aria (bocca libera) AirFlow (free mouth)	530 m3/h
Assorbimento Elettrico Power consumption	Servizi @24V=18Ah – Services @ 24V = 18Ah Condizionamento 24V=40-43Ah – Air conditioning 24V = 40-43Ah
Velocità ventilatore Ventilation Speed	3
Refrigerante - Refrigerant	R134a (incluso – included)
Peso - weight	31 Kg
Note	